

Blaze ASI-5

Airspeed Indicator (ASI)

Operating Manual – English 1.01

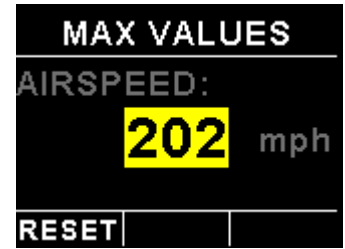
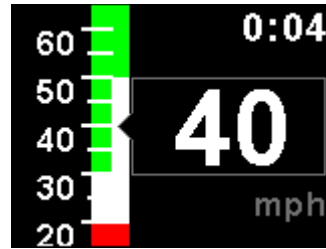

Introduction

The ASI-5 is a 3 1/8" sunlight readable instrument that provides a wide range airspeed indication in both digital and analog tape formats. Airspeed is based on the pressure generated by a pitot tube system and a static port is provided as well for use by high speed aircraft. In addition, the ASI-5 provides a flight timer since takeoff and records the maximum airspeed reached.

Airspeed can be indicated in statute miles per hour (mph), kilometers per hour (km/h) or nautical miles per hour (kts). The analog airspeed tape can be scaled according to the aircraft's flying speed range and ranges for Vs0, Vs1, Vfe, Vno and Vne can be set. The ASI-5 also provides a programmable Vs and Vne airspeed alarm output. ASI sensitivity can be calibrated by the user to cater for errors caused by pitot tube placement.

The ASI-5 instrument measures airspeed from 16mph to 250mph and is well suited to slower aircraft due to very good sensitivity and linearity at low air speeds.

1 Features

- Large 2.6" high resolution 320x240, IPS (fully viewable in all directions), sunlight readable color LCD display
- Measures airspeed from 16mph to 250mph and is well suited to slow aircraft due to very good sensitivity and linearity at low air speeds
- Includes a flight timer since takeoff
- Airspeed units can be set to miles per hour (mph), kilometer per hour (km/h) or nautical miles per hour (kts)
- Analog tape with programmable ranges for Vs0, Vs1, Vfe, Vno and Vne
- Contains a programmable Vs and Vne airspeed alarm output
- Records maximum airspeed reached in permanent memory
- Standard 3 1/8" aircraft enclosure (can be front or rear mounted)
- The LED backlight can automatically adjust to the ambient light, or it can be manually adjusted in the menu system
- Rotary control plus 2 independent buttons for easy menu navigation and user input
- Wide input supply voltage range of 8 to 30V DC with built in voltage reversal and over voltage protection for harsh electrical environments
- 1 year limited warranty

2 Layout

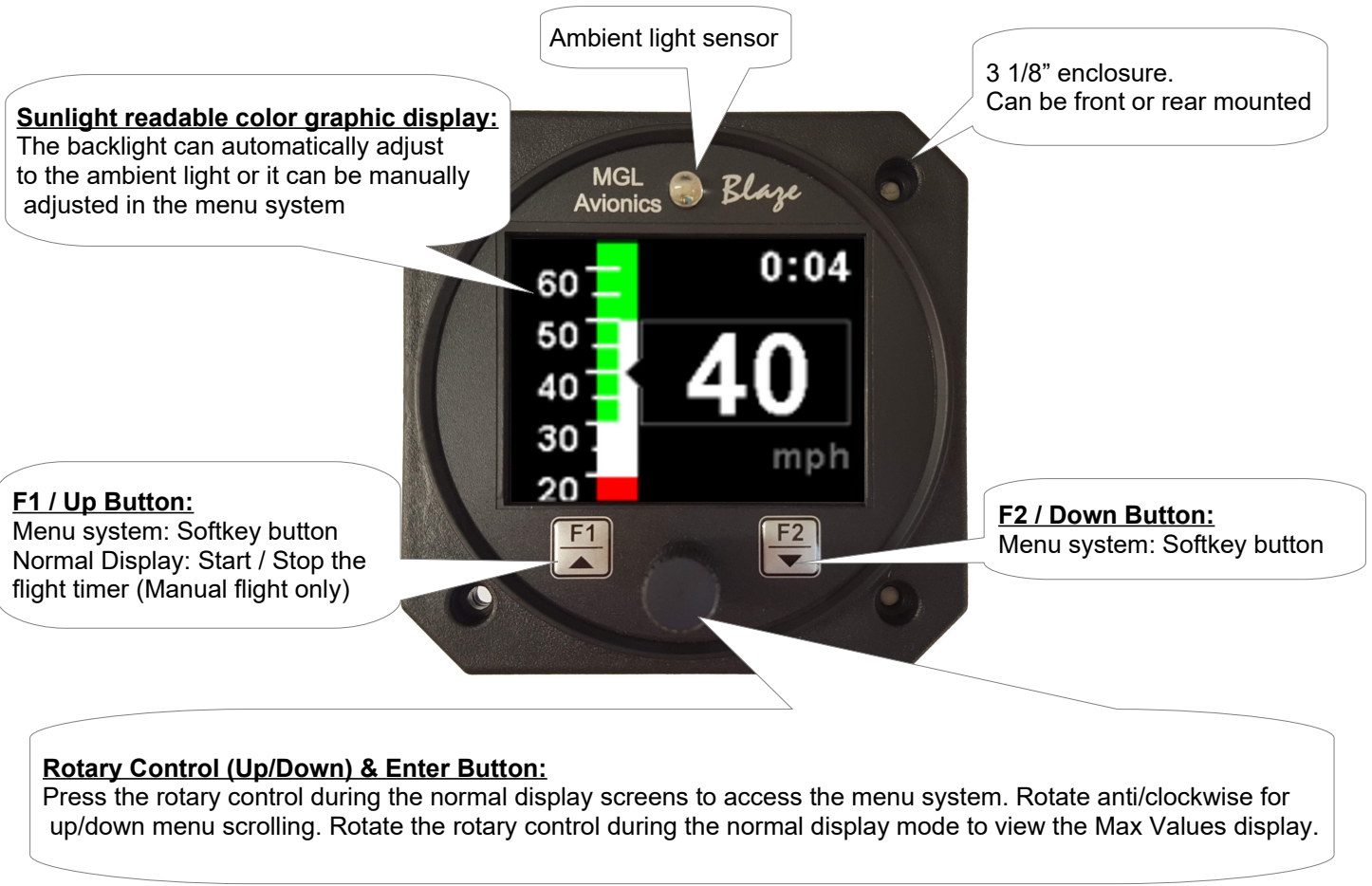

3 Main Display

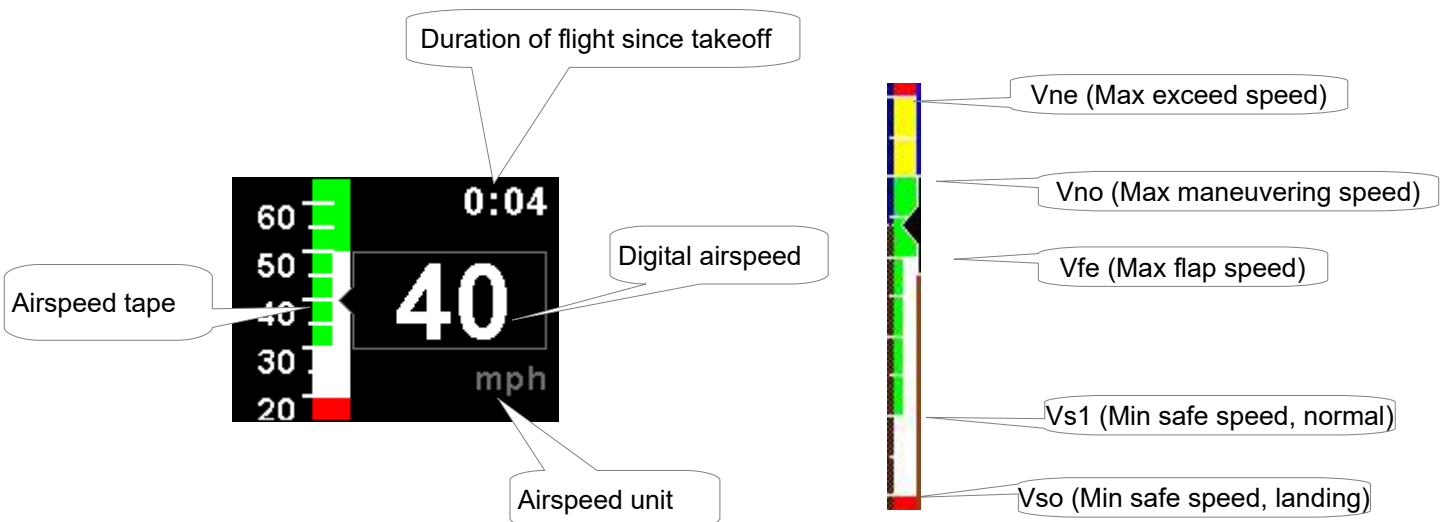

3.1 Maximum Airspeed display

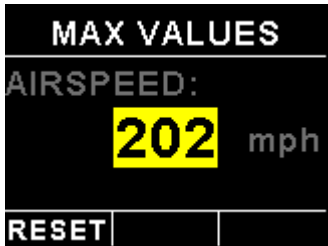

This display can be accessed by rotating the rotary control during the normal display mode. Press the F1/Up button when the max values display is showing to reset the maximum values to the current airspeed.

Note: The maximum airspeed is stored in non-volatile memory and is recalled on power-up.

3.2 Start / Stop flight display



Press the F1/Up button during the normal display mode to manually start/stop a flight. This key is only active if the ASI-5 is setup to select the manual flight option under the "TIMERS" setup menu.

4 Menu System

Press the rotary control button during the normal display mode to enter the menu system. Use the rotary control to navigate through the menu system.

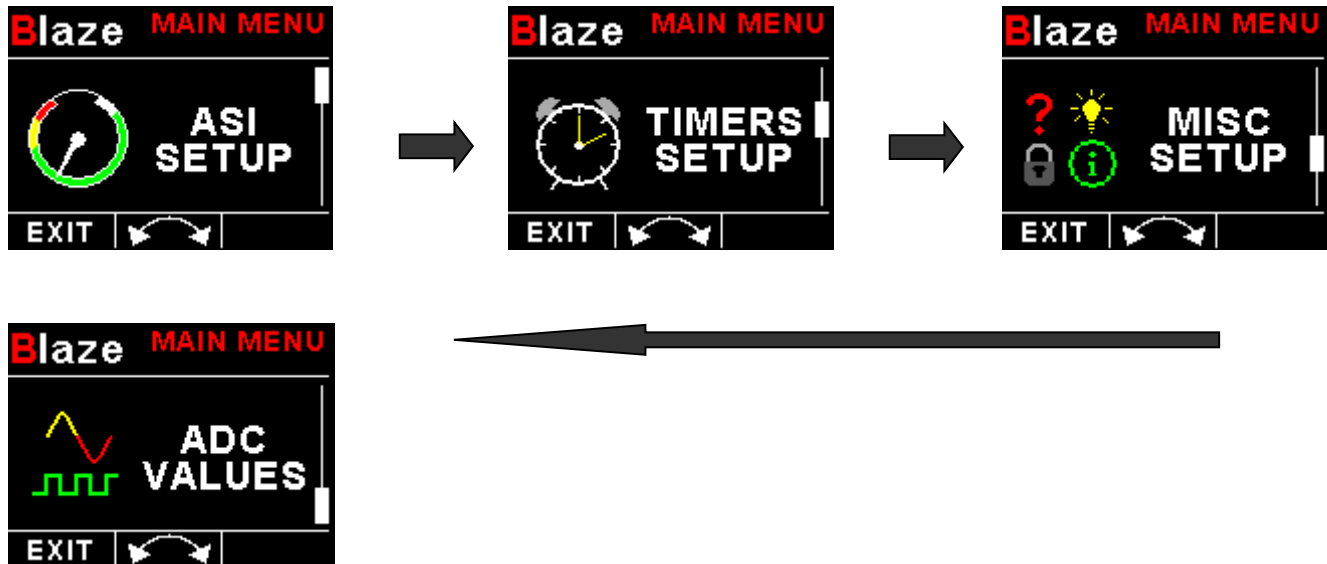

4.1 Exiting the menu system

Press the F1/Up button to exit the menu system when the “EXIT” soft key is shown. All changes made during navigation of the menu system will be saved in non-volatile memory upon exiting. The instrument will not save any changes if you remove power before exiting the menu system.

4.2 ASI Setup (Airspeed Setup)



Zero ASI Sensor:

This setup allows your instrument to measure the zero airspeed reading of the airspeed sensor and set a calibration value internally for this. This is equivalent to some mechanical airspeed indicators that have an adjustment to set the needle to zero when the aircraft is not moving. You would use this function occasionally if you see an airspeed reading when the aircraft is at rest. This may be caused by aging of the built in pressure sensor or related electronics. When this function is performed make sure that there is no air flow into the pitot tube as this would result in an incorrect internal calibration.

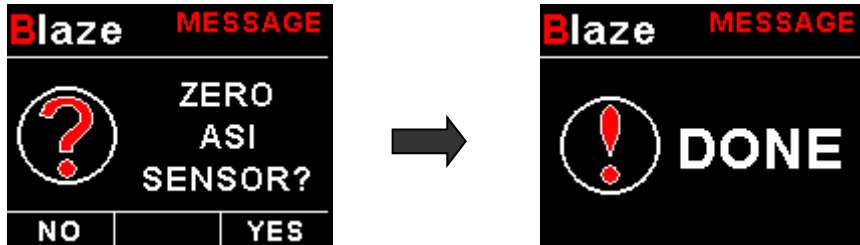
**ASI Unit:**

Select if you want the ASI to be displayed in mph (statute miles per hour), km/h (kilometers per hour) or kts (nautical miles per hour).

ASI Filter:

This function can be used to select the signal filter time constant. Selections are "NONE", "FAST" or "SLOW". This selection influences the rate at which your ASI can change its reading. If you have an installation that suffers from strong turbulence at the pitot tube, select "slow". If you have a very clean airflow in front of the pilot tube you can select "fast" which will give you a faster response to airspeed changes.

ASI Span:

Select the maximum airspeed that you want the airspeed tape to display. This can give you increased display resolution.

ASI In View:

Adjust this setting to set the amount of tape to view. For example, setting this value to 30% and your "ASI SPAN" to 250 will result in the tape showing 75 on the display at a time.

Vne Speed: (Max Exceed Speed)

Enter your maximum speed your aircraft should not exceed.

Vno Speed: (Max Maneuvering Speed)

Enter your maximum maneuvering speed.

Vfe Speed: (Max Flap Speed)

Enter the maximum speed that is permissible with the flaps extended.

Vs1 Speed: (Min Safe Speed, Normal)

Enter your minimum safe speed for normal flight of your aircraft

Vs0 Speed: (Min Safe Speed, Landing)

Enter your minimum safe speed for landing your aircraft

Vs Alarm:

This enables or disables Vs Alarm.

Vne Alarm:

This enables or disables the VNE alarm.

Cal:
During the factory calibration a factor has been determined and entered here that will give you accurate airspeed, provided your pitot tube is not influenced by pressure effects caused by airflow around your airframe. The calibration is displayed in % of the reading, you can increase or decrease the reading if required to help cancel out under or over reading of the airspeed indicator on your aircraft. The original calibration factor has been written onto the back of your instrument.

4.3 Timers Setup



FLIGHT:

Select whether you want the ASI-5 to automatically detect a flight or whether the pilot must press the F1/Up button to start/stop a flight. We recommend you select automatic flight detection.

T/O AIRSPEED:

This menu option is only shown if the "DETECT" flight mode is selected. Enter the takeoff airspeed threshold that you want the flight timer to start incrementing.

4.4 MISC Setup (Miscellaneous Setup)



Backlight:



Select manual or automatic backlight control.

Use the rotary control in manual mode to adjust the backlight brightness.



Allow 3 seconds for the display to adjust to the ambient lighting conditions when using the automatic backlight mode. The display will set the backlight to the dim setting if the ambient light is less than the threshold setting, alternatively the display will set the backlight to the bright setting if the ambient light is greater than the threshold setting. The ambient light received is shown as the ADC value in the top header. Use this value to set the threshold value.

Security Setup:



Select this menu option if you want to password protect the menu system.



Information:

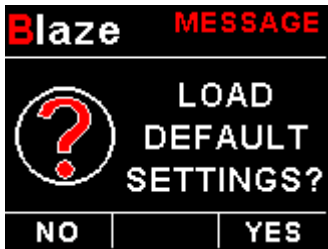

This menu option displays information about the unit.

Default Settings:

Select this menu option to reset all the settings to factory defaults.

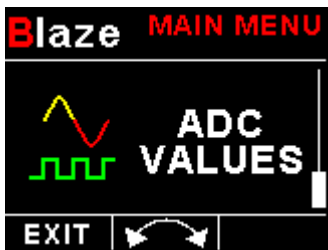
4.5 ADC Values

This menu displays the ADC value that have been read from the pressure sensor.

**5 Loading factory default settings**

Press and hold the F1/Up button and rotary control during power up to load the pre-programmed factory default settings. The following screen will be displayed:

Factory default settings can also be loaded in the Miscellaneous setup menu.

6 Error Messages



**UNIT
SETTINGS
CRC ERROR**

Unit settings CRC error. Load default settings to restore to factory defaults. If the error message still persists then it could possibly be a non-volatile memory failure in which case the instrument will then have to be returned to the factory.



**CALIBRATION
CONSTANTS
CRC ERROR**

Calibration constants CRC error. The instrument could possibly have a non-volatile memory failure in which case the instrument will then have to be returned to the factory.



**INTERNAL
FLASH
CRC ERROR**
UNIT:123456
CODE:654321

Internal flash CRC error. The instrument does a firmware check on the program when power is applied to the instrument . If the program is corrupt in any way then the internal flash CRC error will be displayed. Reload the instruments firmware and load default settings. If the error message still persists then it could possibly be an internal flash memory failure in which case the instrument will then have to be returned to the factory.



**MAX VALUES
CRC ERROR**

Max Values CRC error. Load default settings to restore to factory defaults. If the error message still persists then it could possibly be a non-volatile memory failure in which case the instrument will then have to be returned to the factory.

7 Specifications

Operating Temperature Range	-10°C to 60°C (14°F to 140°F)
Storage Temperature Range	-20°C to 80°C (-4°F to 176°F)
Humidity	<85% non-condensing
Power Supply	8 to 30Vdc SMPS (switch mode power supply) with built in 33V over voltage and reverse voltage protection
Current Consumption	Approx. 130mA @ 12V (backlight highest setting), 50mA @12V (backlight lowest setting)
Display	2.6" 320x240 IPS color LCD display Minimum 600cd/m2 brightness Sunlight readable with anti-glare coating LED Backlight can be set to automatic or can be manually adjusted
Alarm Output	Open collector transistor switch to ground Maximum rating 0.25A
Dimensions	see Blaze series dimensional drawing
Enclosure	3 1/8" ABS, black in color, front or rear mounting. Flame retardant.
Weight	Approx. 160 grams (Instrument excluding cables)
Non-volatile memory storage	100000 write cycles
Airspeed ADC resolution	12 bit
Airspeed range	16mph to 250mph
Airspeed resolution	1 mph
Measurement accuracy	+/-1% at 85mph nominal
Calibration interval	1 Year

8 Operating the alarms

The alarm output can be used to switch an external alarm indicator. The external alarm switch is an open collector transistor switch to ground with a maximum rating of 0.25A DC. It is possible to wire the alarm contacts of several Stratomaster instruments in parallel should this be desired. To avoid false activation of the alarms, the alarm function is only active 5 seconds after the instrument has powered up.

9 Firmware Upgrading

The ASI-5 can be upgraded in the field by connecting the RS232 port to a PC and running the firmware update program. **Note that only the RS232 port can be used to upgrade the firmware.**

Please see the Blaze firmware upgrading document for more information.

10 Cleaning

The unit should not be cleaned with any abrasive substances. The screen is very sensitive to certain cleaning materials and should only be cleaned using a clean, damp cloth.

Warning: The ASI-5 is not waterproof, serious damage could occur if the unit is exposed to water and/or spray jets.

11 Installation

Connect a pitot tube to the “pressure port” and if required connect the static port. Most small aircraft such as ultralights or microlights do not require a connection to a static port. In these cases, simply leave the static port open. Ensure however that the static port does not receive pressurized air due to the forward movement of the aircraft. Be especially critical of your pod or panel if you do not use a static port. Any build up of a pressure differential due to ram air or suction can lead to large errors of the indicated airspeed. Static ports are usually mounted at a strategic position on the rear side of the aircraft fuselage for faster, pressurized aircraft.

The ASI-5 pressure ports take 4mm ID tubing. Use hose clamps to fasten the hose onto the ASI-5 pitot and static ports.

The ASI-5 allows you to calibrate the airspeed reading. This is done under the “AIRSPEED SETUP” menu item. The main reason for this is to be able to remove errors introduced due to the airflow around your aircraft which may have an effect on your pitot tube pressure.

11.1 Connection Diagram

The use of an external 1A fuse is recommended. Connect the supply terminals to your aircrafts power supply. The ASI-5 can be used on both 12V and 24V without the use of any pre-regulators. Ensure that the supply voltage will not drop below 8V during operation as this may result in incorrect readings.

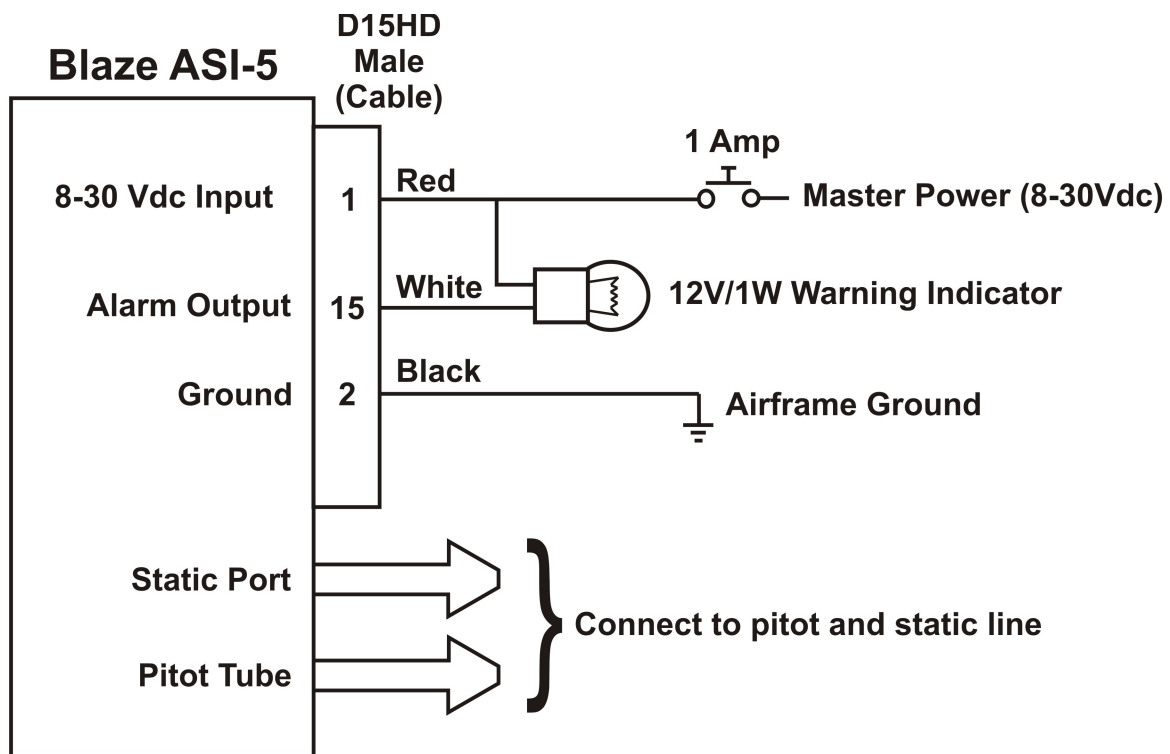

11.2 Pressure Port Dimensions

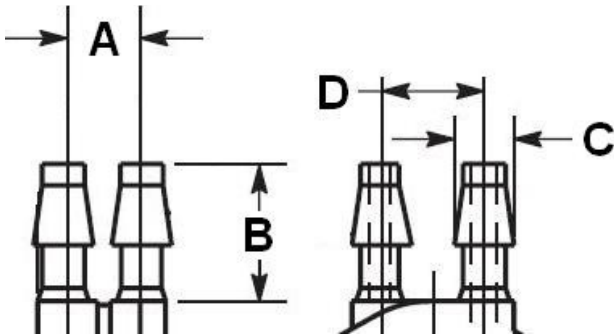

	Inches		Millimeters	
	Min	Max	Min	Max
A	0.248	0.278	6.30	7.06
B	0.420	0.440	10.67	11.18
C	0.182	0.194	4.62	4.93
D	0.310	0.330	7.87	8.38

11.3 Cable connections

Main connector (D15HD connector: Unit Female, Cable Male)

D15 Pin	Color	Function
1	Red	8-30Vdc power via power switch / circuit breaker and fuse.
2	Black	Ground.
3	-	RS232 Transmit data (Firmware upgrading)
4	-	RS232 Receive data (Firmware upgrading)
15	White	Alarm Output (Open collector)

12 Warranty

This product carries a warranty for a period of one year from date of purchase against faulty workmanship or defective materials, provided there is no evidence that the unit has been mishandled or misused. Warranty is limited to the replacement of faulty components and includes the cost of labor. Shipping costs are for the account of the purchaser.

Damage as a result of applying excessive pressure to the pressure ports are excluded from warranty.

Note: Product warranty excludes damages caused by unprotected, unsuitable or incorrectly wired electrical supplies and or sensors, and damage caused by inductive loads.

13 Disclaimer

Operation of this instrument is the sole responsibility of the purchaser of the unit. The user must make themselves familiar with the operation of this instrument and the effect of any possible failure or malfunction.

This instrument is not certified by the FAA. Fitting of this instrument to certified aircraft is subject to the rules and conditions pertaining to such in your country. Please check with your local aviation authorities if in doubt. This instrument is intended for ultralight, microlight, homebuilt and experimental aircraft. Operation of this instrument is the sole responsibility of the pilot in command (PIC) of the aircraft. This person must be proficient and carry a valid and relevant pilot's license. This person has to make themselves familiar with the operation of this instrument and the effect of any possible failure or malfunction. Under no circumstances does the manufacturer condone usage of this instrument for IFR flights.

IMPORTANT NOTICE:

You must make your own determination if the products sold by MGL Avionics are safe and effective for your intended applications. MGL Avionics makes no representations or warranties as to either the suitability of any of the products we sell as to your particular application or the compatibility of any of the products we sell with other products you may buy from us or anywhere else, and we disclaim any warranties or representations that may otherwise arise by law. Also, we offer no specific advice on how to install any of the products we sell other than passing along anything that may have been provided to us by the manufacturer or other issues. If you are in need of further information or guidance, please turn to the manufacturer, FAA Advisory Circulars and guidance materials, the Experimental Aircraft Association, or other reputable sources.

The manufacturer reserves the right to alter any specification without notice.

Other instruments in the *Stratomaster Blaze* series

AHRS-2	Artificial Horizon and Magnetic Compass Indicator
ALT-6	Altimeter and Vertical Speed Indicator (VSI)
ALT-7	Altimeter and Vertical Speed Indicator (VSI) with a transponder compatible RS232 & parallel Gillham code output
ASI-5	Airspeed Indicator (ASI)
ASV-2	Altimeter, Airspeed (ASI) and Vertical Speed Indicator (VSI)
EMS-2	Engine Monitoring System
FF-5	Fuel Computer
FLIGHT-3	Primary Flight Instrument
INFO-2	Information Display (G-Force meter, UTC and Local Time, Slip Indicator, Outside Air Temperature (OAT), Battery Voltage, Current and charge display, Flight Timer & Flight Log, Stopwatch, Countdown Timer and Alarm)
MAG-2	Magnetic Compass Indicator
MAP-4	Manifold Pressure and RPM Indicator
RPM-2	Universal Engine / Rotor RPM Indicator
TC-5	4 Channel Thermocouple (EGT/CHT) Indicator
TC-6	12 Channel Thermocouple (EGT/CHT) Indicator
TP-4	4 Channel Universal Analog Input (Pressure/Temperature/Current/Volts) Indicator