

# Blaze ALT-7

Altimeter and Vertical Speed Indicator  
with a transponder compatible serial  
RS232 & parallel Gillham code output

Operating Manual – English 1.06

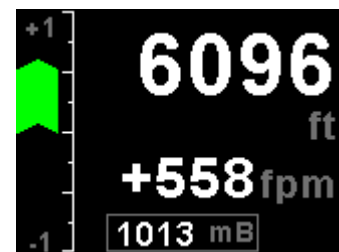
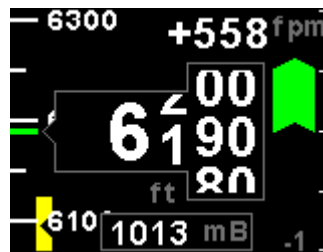

## Introduction

The ALT-7 is a 3 1/8" (80mm) sunlight readable encoding altimeter and a wide range vertical speed indicator.

The altimeter contains an internal high accuracy 24 bit digital altitude sensor which calculates altitude from -1500 ft up to a maximum of +35000 ft. The ALT-7 outputs various formatted RS232 serial data protocols compatible with serial input transponders such as that from Garmin, Magellan, Northstar, Trimble, Microair etc. The altimeter can display altitude in feet or meters and local pressure can be set in millibars or inches of mercury.

The VSI indicator can be displayed in either feet/minute (ft/min) or meters/second (m/s). The VSI can be calibrated by the user once the instrument has been installed in the aircraft.

The ALT-7 also provides a transponder compatible Serial RS232 and parallel Gillham code output and also features a user settable altitude bug and an encoder test function.

## 1 Features

- Large 2.6" high resolution 320x240, IPS (fully viewable in all directions), sunlight readable color LCD display
- An internal high accuracy 24 bit digital altitude sensor calculates altitude from -1500 ft up to a maximum of +35000 ft (-457m to +10668m)
- The ALT-7 outputs various formatted RS232 serial data protocols compatible with serial input transponders such as that from Garmin, Magellan, Northstar, Trimble, Microair etc.
- Provides a parallel Gillham code output for transponders
- Built in encoder test function
- The altimeter can display altitude in feet or meters
- Local pressure can be set in millibars or inches of mercury
- Contains a wide range VSI indicator from +/-20 ft/min to as high as +/-10000 ft/min
- VSI units can be in feet/minute (ft/min) or in meters/second (m/s)
- User settable altitude bug with deviation band alarm
- Standard 3 1/8" (80mm) aircraft enclosure (can be front or rear mounted)
- The LED backlight can automatically adjust to the ambient light, or it can be manually adjusted in the menu system
- Rotary control plus 2 independent buttons for easy menu navigation and user input
- Wide input supply voltage range of 8 to 30V DC
- 1 year limited warranty

## 2 Layout



**Sunlight readable color graphic display:**  
The backlight can automatically adjust to the ambient light or it can be manually adjusted in the menu system

Ambient light sensor

3 1/8" (80mm) enclosure.  
Can be front or rear mounted

**F1 / Up Button:**  
Menu system: Softkey button  
Normal display: Enable/disable altitude bug

**F2 / Down Button:**  
Menu system: Softkey button  
Normal display: Altitude bug setting display

**Rotary Control (Up/Down) & Enter Button:**  
Press the rotary control during the normal display screens to access the menu system. Rotate anti/clockwise for up/down menu scrolling. Rotate the rotary control during the normal display mode to adjust the local pressure. Local pressure can be set in either mB or in "Hg.

## 3 Main Displays

The ALT-7 has 2 different display screens. The main display screen can be selected in the "ALT SETUP" menu.

### 3.1 Altitude "TAPE" Display

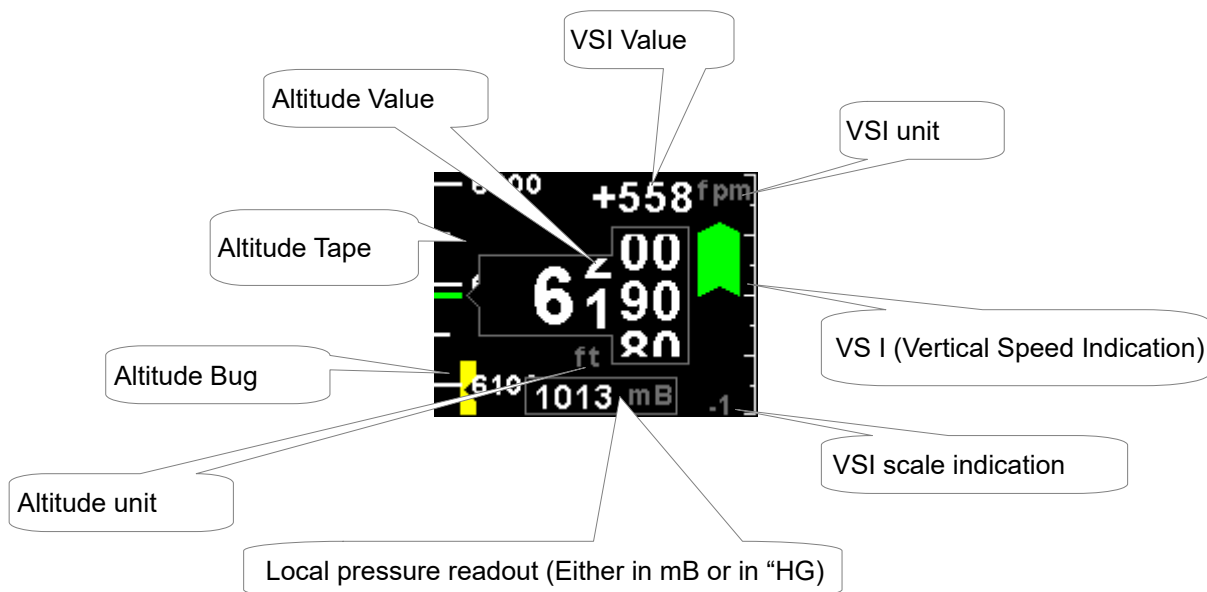

### 3.2 Altitude "CLASSIC" Display

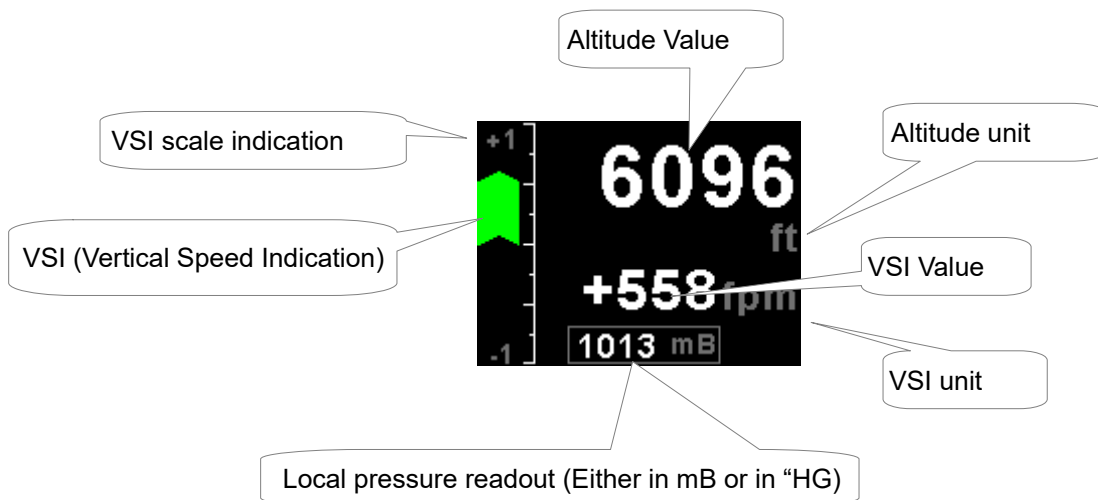

### 3.3 Altitude Bug



Press the F2/Down button during the altitude "TAPE" display to access the altitude bug setting screen. Press the F1/UP key to set the altitude bug to the current altitude or use the rotary control to adjust the altitude bug. Press the F2/Down key to change the increment / decrement unit to 50 or 500. Press the rotary control to exit and save.

Press the F1/Up button during the normal altitude "TAPE" display to enable or disable the altitude bug. The bug will be yellow when in the display screen and cyan when either above or below the limits of the display.

### 3.4 Deviation Band



Use the rotary control to adjust the altitude deviation band. Press the F2/Down key to change the increment / decrement unit to 50 or 100. Press the rotary control to exit and save.

## 4 Menu System

Press the rotary control button during the normal display mode to enter the menu system. Use the rotary control to navigate through the menu system.



### 4.1 Exiting the menu system

Press the F1/Up button to exit the menu system when the "EXIT" soft key is shown. All changes made during navigation of the menu system will be saved in non-volatile memory upon exiting. The instrument will not save any changes if you remove power before exiting the menu system.

## 4.2 ALT Setup (Altitude Setup)



### **Style:**

Select the altitude display screen. Options include "TAPE" or "CLASSIC".

### **Altitude Unit:**

Select if you want the altitude displayed in ft (feet) or m (meters).

### **Pressure Unit:**

Select if you want the local pressure displayed in mb (millibars) or "Hg (inches of mercury).

### **Resolution:**

Select the resolution of the altitude value, a selection of 1,10,25 or 100 ft or m can be selected.

### **ALT Calibrate**

This section allows for the calibration and fine tweaking of the altitude value. Before you begin, ensure that your calibrated and certified reference is set to the local pressure of 1013.25mB (29.92"Hg). The ALT-6 altitude value in ft (referenced to 1013.25mB (29.92"Hg)) is displayed in the top right hand corner of the display. All calibration must be done in feet.

The combined adjustments cater for both the altitude sensors offset and gain. Only start the calibration sequence once the instrument has been running for a minimum of 10 minutes.

Start the altitude calibration with the "CAL FACTOR" and make sure the "CAL GAIN" value is set to 100.00%.



**Cal Factor:**

This is the pressure sensor offset in 0.1mB increments. Adjust your static pressure to be close to sea level pressure. The exact altitude is not important and can be up to several hundred feet. Adjust the calibration factor so the altitude readout in the top right hand corner of the display agrees with your pitot static test set.

**Cal Gain:**

Once you are satisfied that the low level altitude "CAL FACTOR" is correct, apply a static pressure that will result in an altitude between 20000 and 30000 ft. Adjust the "CAL GAIN" until the altitude readout in the top right hand corner of the display agrees with your pitot static test set

**NOTE:** Adjusting the "CAL GAIN" also changes the low level altitude calibration achieved when adjusting the "CAL FACTOR". Please recheck your low level altitude calibration and adjust if necessary. Recheck your altitude readout at the higher altitude, and if needed slightly adjust the "CAL GAIN" again. Repeat the process until you are satisfied with both the "CAL FACTOR" altitude and the "CAL GAIN" altitude.

**Serial Out:**

Select "ON" to enable the RS232 serial altitude output. This formatted serial RS232 message can be directly interfaced to various RS232 serial input transponders.

**Prot:**

Select the protocol of the serial RS232 output message. The protocol can be selected between GARMIN AT, Magellan, Northstar / Garmin, Trimble / Garmin, MGL Avionics and Microair UAV. Please note that the baud rate is automatically adjusted according to which protocol is selected. The output format is as follows. The message contains the current pressure altitude with a fixed reference to 1013.25mB (29.92 inches mercury). All protocols use 8 databits, no parity, and 1 stop bit. The message is outputted once a second.

Protocol	Baud Rate	Message format	Example
Garmin AT	1200	#AL, space, +/-, five altitude digits right justified zero padded, T+25, checksum, carriage return  The checksum is a simple modulo 256 sum of the binary values of the individual characters. The checksum is sent as two characters in hexadecimal format	#AL +02372T+25DF[CR]
Magellan	1200	#MGL, +/-, five altitude digits right justified zero padded, T+25, checksum, carriage return  The checksum is a simple modulo 256 sum of the binary values of the individual characters. The checksum is sent as two characters in hexadecimal format	\$MGL+02372T+2513[CR]
Northstar, Garmin	4800	ALT, space, five altitude digits right justified zero padded, carriage return	ALT 02372[CR]
Trimble, Garmin GTX327, GTX328, GTX330 (Set on Icarus)	9600	ALT, space, five altitude digits right justified zero padded, carriage return	ALT 02372[CR]
MGL Avionics	9600	ALT, +/-, five altitude digits right justified zero padded ,1013.25mB (29.92"Hg) referenced, C, +/-, five altitude digits right justified zero padded (corrected to local pressure), L, local pressure setting in	ALT+02372C+02372L1013+0000XCA[CR]

		millibars,+/-, four digit VSI reading right justified zero padded in ft/min, X, checksum, carriage return  The checksum is a simple modulo 256 sum of the binary values of the individual characters. The checksum is sent as two characters in hexadecimal format	
Microair UAV	9600	STX,a,=, five altitude digits right justified zero padded, ETX	[STX]a=02372[ETX]
Infiniteq	57600	See Infiniteq protocol format below	
STX=0x02 ETX=0x03 CR=0x0D			

### Infiniteq protocol format:

#### STX, Address, Message type, Length, Data payload, Checksum, ETX

STX: Start of text (0x02)

Address: unsigned char (8bit), (0x01)

Message Type: unsigned char (8bit), (0x05)

Length: unsigned char (8bit), Length of the data payload (does not include the STX, Address, message type, checksum or ETX), (0x06)

Data payload:

Altitude: Signed Long (32 bit), Altitude in feet (Referenced to 1013.25mB)

Vertical Speed: Signed Int (16 bit), Vertical Speed in ft/min

Checksum: unsigned char (8bit), XOR of all bytes starting from the unit address to the end of the data payload. The checksum is seeded with 0xa5. (does not include the STX or ETX)

ETX: End of text (0x03)

**Test Alt Encoder:**

This is a handy function to test the ALT-7 transponder interface once the installation has been completed. The serial output will output specific altitudes which can then be used to test the serial RS232 output and the parallel gillham output. The ALT-7 will resume the normal output of the indicated altitude upon exiting the test function.

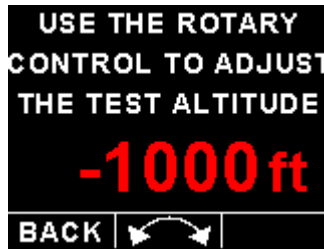

The following codes are outputted:

Altitude	D4	A1	A2	A4	B1	B2	B4	C1	C2	C4
-1000ft	0	0	0	0	0	0	0	0	1	0
-900ft	0	0	0	0	0	0	0	1	1	0
-700ft	0	0	0	0	0	0	1	1	0	0
-400ft	0	0	0	0	0	0	1	0	1	1
-200ft	0	0	0	0	0	1	1	0	0	1
800ft	0	0	0	0	1	1	0	0	0	1
2800ft	0	0	0	1	1	0	0	0	0	1
6800ft	0	0	1	1	0	0	0	0	0	1
14800ft	0	1	1	0	0	0	0	0	0	1
30800ft	1	1	0	0	0	0	0	0	0	1

Each altitude reporting code line must be tested for integrity of connection if at any time the aircraft connections to the transponder or altitude data source have been removed and reconnected. Integrity of the connections may be verified by performing a test of mode C function of the transponder system.

**Warning:** Do not use this function while in flight as incorrect altitude information will be sent to the transponder.



## 4.3 VSI Setup (Vertical Speed Indicator Setup)



### **VSI Display:**

Select if you want the VSI display to be shown on the altitude "TAPE" display. The VSI display is always shown on the altitude "CLASSIC" display.

### **VSI Unit:**

Select if you want the VSI to be displayed in "ft/min" (feet/minute) or "m/s" (meters/second).

### **Scale:**

Select the VSI scale most suited for your aircraft.

### **VSI Cal:**

This is a function that is used to calibrate your VSI to read exact rates of climb or decent. This function works as a percentage of initial reading. The default setting for this function is 100%. Increasing this value increases the VSI reading and decreasing the value decreases the reading.

### **Suggested VSI calibration method**

After you have installed the instrument, perform a calibration flight. This should be done in very calm conditions. Turbulence and thermal activity will make accurate calibration impossible. Many areas have ideal conditions during early mornings or late afternoons. Place the instrument in ft/min for ease of calibration. Take your aircraft to a few thousand feet above ground and start a glide with a low power setting. Take a stopwatch and when the glide is stable (stable VSI reading) start the stopwatch. Take note of your altimeter reading at the same time. Continue the stable glide for one minute exactly. After the minute has finished, take another reading of your altimeter.

### **Example:**

VSI reading during stable glide: -400 ft/min

Start altitude: 2500 ft.

End altitude: 2050 ft.

In the above example the VSI is under reading by about 12%. Set your VSI calibration to 112% to cancel out the error.

### 4.4 MISC Setup (Miscellaneous Setup)



**Backlight:**



Select manual or automatic backlight control.

Use the rotary control in manual mode to adjust the backlight brightness.



Allow 3 seconds for the display to adjust to the ambient lighting conditions when using the automatic backlight mode. The display will set the backlight to the dim setting if the ambient light is less than the threshold setting, alternatively the display will set the backlight to the bright setting if the ambient light is greater than the threshold setting. The ambient light received is shown as the ADC value in the top header. Use this value to set the threshold value.

**Security Setup:**



Select this menu option if you want to password protect the menu system.

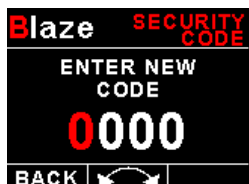
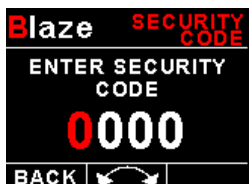

**Information:**



This menu option displays information about the unit.

**Default Settings:**

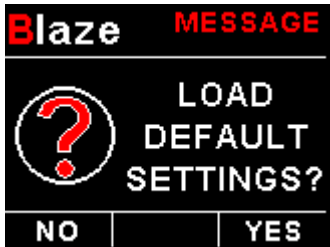

Select this menu option to reset all the settings to factory defaults.

## 5 Loading factory default settings



Press and hold the F1/Up button and rotary control during power up to load the pre-programmed factory default settings. The following screen will be displayed:

Factory default settings can also be loaded in the Miscellaneous setup menu.

## 6 Error Messages



**UNIT  
SETTINGS  
CRC ERROR**

Unit settings CRC error. Load default settings to restore to factory defaults. If the error message still persists then it could possibly be a non-volatile memory failure in which case the instrument will then have to be returned to the factory.



**CALIBRATION  
CONSTANTS  
CRC ERROR**

Calibration constants CRC error. The instrument could possibly have a non-volatile memory failure in which case the instrument will then have to be returned to the factory.



**INTERNAL  
FLASH  
CRC ERROR**  
UNIT:123456  
CODE:654321

Internal flash CRC error. The instrument does a firmware check on the program when power is applied to the instrument . If the program is corrupt in any way then the internal flash CRC error will be displayed. Reload the instruments firmware and load default settings. If the error message still persists then it could possibly be an internal flash memory failure in which case the instrument will then have to be returned to the factory.

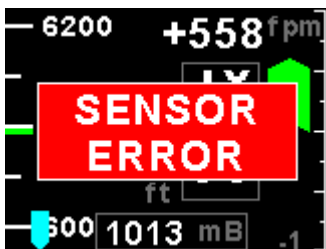

**SENSOR  
ERROR**

Altitude sensor error. The instrument could have a faulty altitude sensor in which case the instrument will then have to be returned to the factory.

## 7 Specifications

Operating Temperature Range	-10°C to +55°C (14°F to 131°F)
Storage Temperature Range	-20°C to 80°C (-4°F to 176°F)
Humidity	<85% non-condensing
Power Supply	10 to 30Vdc
Current Consumption	Approx. 125mA @ 12V (backlight highest setting), 45mA @12V (backlight lowest setting)
Display	2.6" 320x240 IPS color LCD display Minimum 600cd/m2 brightness Sunlight readable with anti-glare coating LED Backlight can be set to automatic or can be manually adjusted
Alarm Output	Open collector transistor switch to ground Maximum rating 0.25A
Dimensions	see Blaze series dimensional drawing
Enclosure	3 1/8" (80mm) ABS, black in color, front or rear mounting. Flame retardant.
Weight	Approx. 180 grams (Instrument excluding cables)
Non-volatile memory storage	100000 write cycles
Altitude sensor ADC resolution	24 bit
Altimeter range	-1500ft to +35000ft (-457m to +10668m)
Altitude units	ft or m
Baro Correction Range (inHg)	28.00 to 31.00 "Hg
Baro Correction Range (mB)	946 to 1050 mb
Pressure units	"Hg or mb
VSI range	+/-20ft/min to +/-10000ft/min
VSI units	ft/min or m/s
Serial Port	RS232 voltage levels
Calibration interval	1 Year
Gillham code port	D15F connector (Cable is Male), Open collector darlington drivers

## 8 Operating the alarms

The alarm output can be used to switch an external alarm indicator. The external alarm switch is an open collector transistor switch to ground with a maximum rating of 0.25A DC. It is possible to wire the alarm contacts of several Stratomaster instruments in parallel should this be desired.

## 9 Firmware Upgrading

The ALT-7 can be upgraded in the field by connecting the RS232 port to a PC and running the firmware update program. **Note that only the RS232 port can be used to upgrade the firmware.**

Please see the Blaze firmware upgrading document for more information.

## 10 Installation

Connect the static port to a suitable static air pressure line. If you have a slow aircraft or an aircraft where the internal cabin pressure does not change during flight and is equivalent to the outside air pressure you may find that it is not required to connect a static port.

For installations in typical ultralight aircraft pods, be aware of possible pressure changes inside the pod during flight caused by ram air or suction effects. This may lead to a false indication of altitude. Often these effects are dependent on the current angle of attack of the airflow around your pod. You will need to install a suitable static port in these cases.

The ALT-7 static pressure port takes 4mm ID tubing. Use hose clamps to fasten the hose onto the ALT-7 static port.

### 10.1 Gillham Encoder transponder interface

The ALT-7 altimeter will measure altitudes typically to around 42 000 ft, however, this requires a transponder that uses signal D4. Transponders that do not have D4 can only transmit altitudes up to 35000 ft. If your transponder only accepts codes A1 to C4 then you leave signal D4 unconnected. The ALT-7 produces inverted Gillman codes as required by virtually all transponders. The outputs are open collector types and will sink currents up to a few mA.

It is recommended to use shielded cable for the connection between the ALT-7 and the transponder if a long cable needs to be used. The shield should be connected to ground at one point only (either on the encoding altimeter side or on the transponder side).

The ALT-7 will switch all output drivers off if an error has occurred with the altitude sensor.

### Important information

Depending on laws and regulations in your country you may not be allowed to install a transponder and associated equipment yourself. This work may have to be done by a certified AMO or instrument technician.

Please check with your relevant authorities.

The ALT-7 encoding altimeter is uncertified equipment and may normally only be used in uncertified aircraft, homebuilt aircraft and microlights (ultralights). Special operations permits for other aircraft may be required. Please be very aware that any wiring mistake related to the application of Gillham codes to your transponder will result in incorrect altitudes broadcast by your transponder. Any installation involving the ALT-7 must be checked by a suitably equipped aircraft instrument maintenance outfit before operation. Failure to do this may be a criminal offence in your country.

**Attention:**

Your country may have regulations that do not allow you to install a transponder or an encoding altimeter yourself. The installation may have to be performed by an authorized person or company. Please check your applicable regulations with your aviation authorities.

## Pinouts for various transponders

The ALT-7 has a parallel output Gillham interface that can be directly connected to various parallel input transponders such as those from Garmin, Becker, King, Microair, etc. The output data contains the current pressure altitude with a fixed reference to 1013.25mB (29.92 inches mercury). The following table is of commonly used transponders and their Gillham code connections. Please consult your transponders installation manual on the physical position of every contact. Ensure that you wire the Gillham codes correctly and securely.

Transponder	A1	A2	A4	B1	B2	B4	C1	C2	C4
ARC RT359A/459A/859A	14	13	15	19	17	16	21	18	20
BECKER ATC 2000/3401	16	15	14	17	19	18	22	21	20
BECKER ATC 4401	1	2	3	14	15	16	17	18	19
BENDIX TRP-2060/2061/660	4	6	8	9	10	11	3	5	7
BENDIX TR541A/641B	A	B	C	D	E	F	H	J	K
COLLINS TDR-950/950L	12	10	7	6	5	4	8	11	9
EDO-AIRE RT-777	7	5	3	12	13	14	8	6	4
GARMIN 320/320A/327	3	5	6	9	11	12	10	4	7
GENAVE BETA 5000	4	5	6	7	8	9	10	11	12
KING KT76/78	6	7	9	4	1	2	3	8	10
KING KT76A/78A/76C/79	M	K	J	E	C	B	D	L	H
KING 750A	G	H	J	K	L	M	P	R	S
KING KT75	6	7	8	9	10	11	12	13	14
MICROAIR T2000	9	10	11	12	13	17	18	19	20
NARCO AT50/50A/150	7	6	8	12	10	9	14	11	13
NARCO AT5/6/6A	2	4	8	9	10	11	1	3	5
RADAIR 250	7	6	13	9	10	11	14	16	12
TERRA TRT250/250D	5	17	16	15	2	14	3	4	18
UPS/APPLLO SL70	13	31	12	33	14	32	16	34	15
WILCOX 1014A	K	C	W	T	L	D	P	F	Z

### 10.2 Connection Diagram

The use of an external 1A fuse is recommended. Connect the supply terminals to your aircrafts power supply. The ALT-7 can be used on both 12V and 24V without the use of any pre-regulators. Ensure that the supply voltage will not drop below 8V during operation as this may result in incorrect readings.

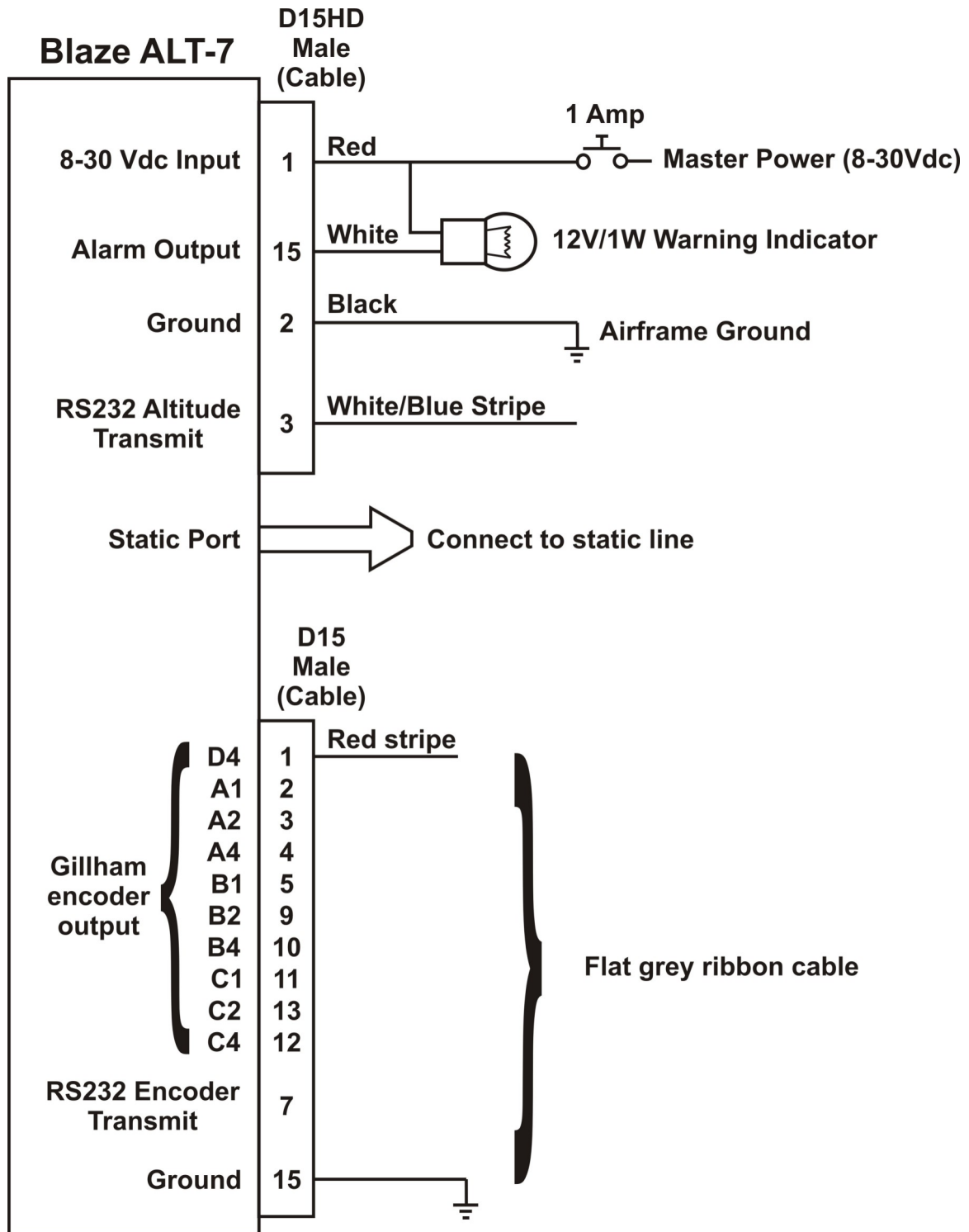



## 10.3 Cable connections

### Main connector (D15HD) connector: Unit Female, Cable Male)

D15HD Pin	Color	Function
1	Red	8-30Vdc power via power switch / circuit breaker and fuse.
2	Black	Ground.
3	White/Blue Stripe	RS232 Transmit data (Firmware upgrading / RS232 Altitude output)
4	-	RS232 Receive data (Firmware upgrading)
15	White	Alarm Output (Open collector)

### Encoder Interface connector (D15 Unit Female, Cable Male)

The Gillham code signals are on the grey flat ribbon cable. Note that one side on the cable is marked with a red line to indicate pin 1.

D15 Pin	Color	Function
1	Red Stripe / Grey	Gillham Output D4
2	Grey	Gillham Output A1
3	Grey	Gillham Output A2
4	Grey	Gillham Output A4
5	Grey	Gillham Output B1
7	Grey	RS232 Transmit output
9	Grey	Gillham Output B2
10	Grey	Gillham Output B4
11	Grey	Gillham Output C1
12	Grey	Gillham Output C4
13	Grey	Gillham Output C2
15	Grey	Ground

# 11 Dimensions

## Stratomaster Blaze 3.125" (80mm) Dimensions

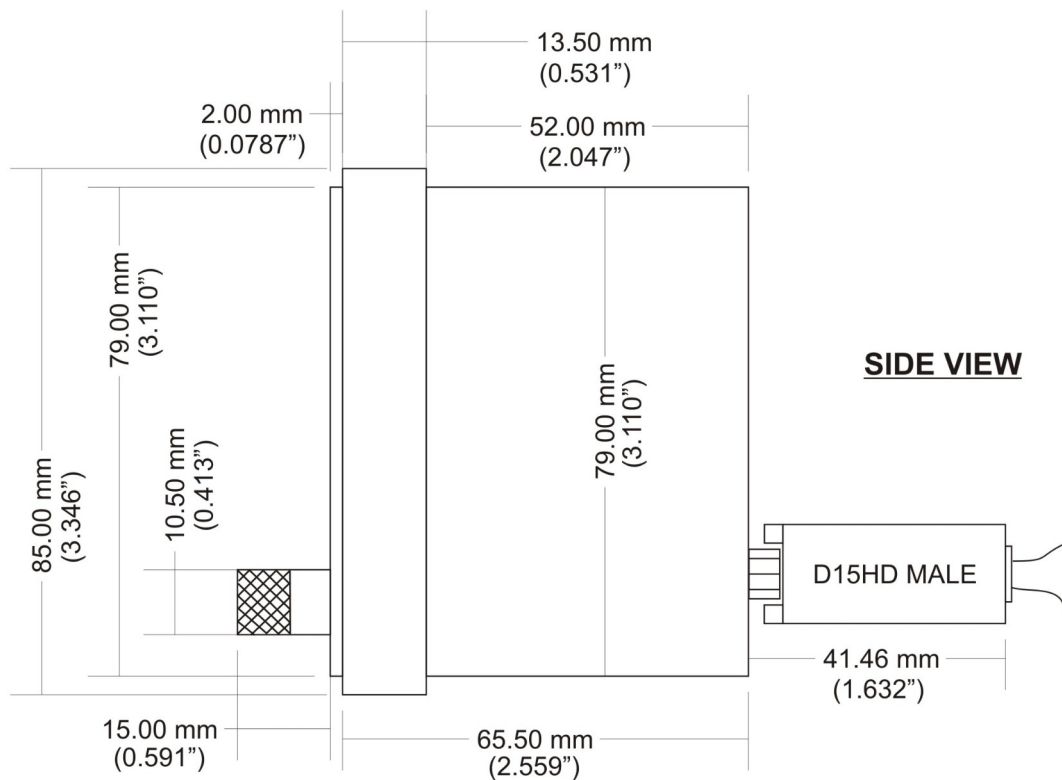
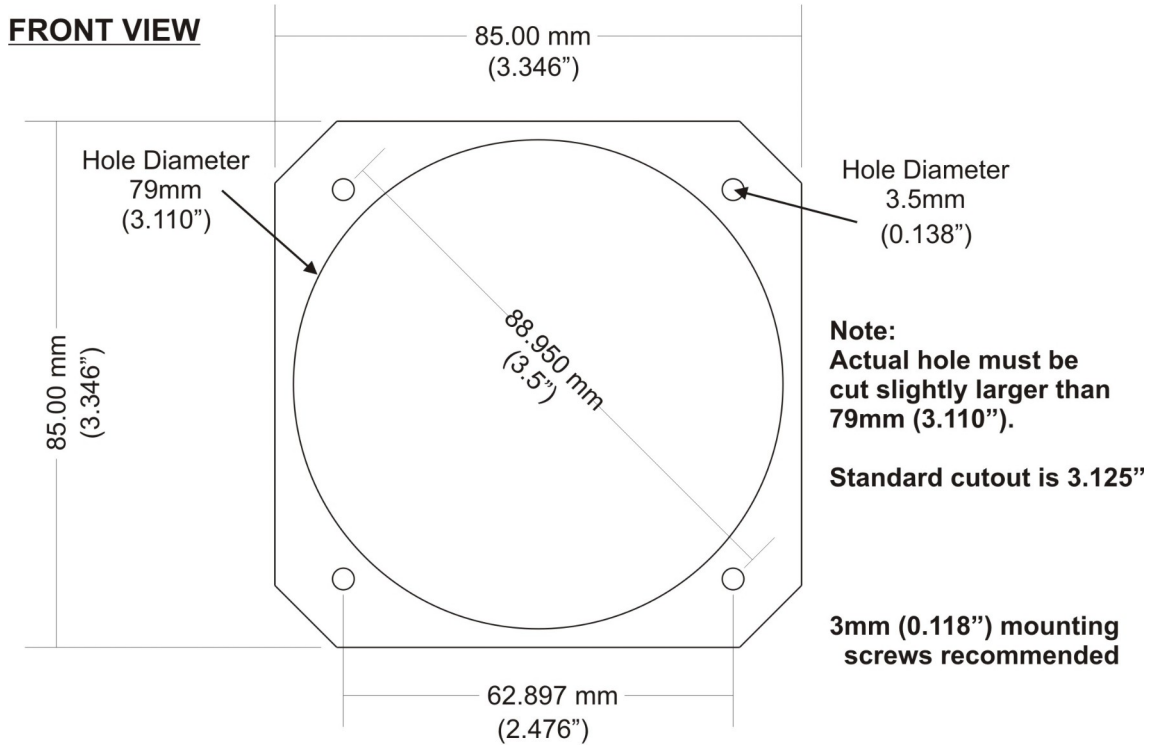

## 12 Cleaning

The unit should not be cleaned with any abrasive substances. The screen is very sensitive to certain cleaning materials and should only be cleaned using a clean, damp cloth.

**Warning:** The ALT-7 is not waterproof, serious damage could occur if the unit is exposed to water and/or spray jets.

## 13 Warranty

This product carries a warranty for a period of one year from date of purchase against faulty workmanship or defective materials, provided there is no evidence that the unit has been mishandled or misused. Warranty is limited to the replacement of faulty components and includes the cost of labor. Shipping costs are for the account of the purchaser.

**Note:** Product warranty excludes damages caused by unprotected, unsuitable or incorrectly wired electrical supplies and or sensors, and damage caused by inductive loads.

## 14 Disclaimer

Operation of this instrument is the sole responsibility of the purchaser of the unit. The user must make themselves familiar with the operation of this instrument and the effect of any possible failure or malfunction.

This instrument is not certified by the FAA. Fitting of this instrument to certified aircraft is subject to the rules and conditions pertaining to such in your country. Please check with your local aviation authorities if in doubt. This instrument is intended for ultralight, microlight, home built and experimental aircraft. Operation of this instrument is the sole responsibility of the pilot in command (PIC) of the aircraft. This person must be proficient and carry a valid and relevant pilot's license. This person has to make themselves familiar with the operation of this instrument and the effect of any possible failure or malfunction. Under no circumstances does the manufacturer condone usage of this instrument for IFR flights.

### **IMPORTANT NOTICE:**

You must make your own determination if the products sold by MGL Avionics are safe and effective for your intended applications. MGL Avionics makes no representations or warranties as to either the suitability of any of the products we sell as to your particular application or the compatibility of any of the products we sell with other products you may buy from us or anywhere else, and we disclaim any warranties or representations that may otherwise arise by law. Also, we offer no specific advice on how to install any of the products we sell other than passing along anything that may have been provided to us by the manufacturer or other issues. If you are in need of further information or guidance, please turn to the manufacturer, FAA Advisory Circulars and guidance materials, the Experimental Aircraft Association, or other reputable sources.

**Continuing development sometimes necessitates specification changes without notice.**

## Other instruments in the *Stratomaster Blaze* series

<b>AHRS-2</b>	Artificial Horizon and Magnetic Compass Indicator
<b>AHRS-4</b>	Self contained Artificial Horizon and Magnetic Compass Indicator
<b>ALT-6</b>	Altimeter and Vertical Speed Indicator (VSI)
<b>ALT-7</b>	Altimeter and Vertical Speed Indicator (VSI) with a transponder compatible RS232 & parallel Gillham code output
<b>ASI-5</b>	Airspeed Indicator (ASI)
<b>ASV-2</b>	Altimeter, Airspeed (ASI) and Vertical Speed Indicator (VSI)
<b>EMS-2</b>	Engine Monitoring System
<b>FF-5</b>	Fuel Computer
<b>FLIGHT-3</b>	Primary Flight Instrument
<b>INFO-2</b>	Information Display (G-Force meter, UTC and Local Time, Slip Indicator, Outside Air Temperature (OAT), Battery Voltage, Current and charge display, Flight Timer & Flight Log, Stopwatch, Countdown Timer and Alarm)
<b>MAG-2</b>	Magnetic Compass Indicator
<b>MAP-4</b>	Manifold Pressure and RPM Indicator
<b>RPM-2</b>	Universal Engine / Rotor RPM Indicator
<b>TC-5</b>	4 Channel Thermocouple (EGT/CHT) Indicator
<b>TC-6</b>	12 Channel Thermocouple (EGT/CHT) Indicator
<b>TP-4</b>	4 Channel Universal Analog Input (Pressure/Temperature/Current/Volts) Indicator